

akcija



unutarnje uređenje

express | 05/2019

schachermayer

Cijene su neto bez PDV-a i važe do 29.02.2020 ili do isteka zaliha. | Osim u slučaju velikog povećanja/smanjenja cijena sirovina.
Cijene važe samo za registrovane kupce.

GranMaster



UGRADBENI SUDOPER RIVA 80



Materijal: granit
 Dimenzije korita: 430 x 440 x 196 i 170 x 350 x 130 mm
 Osnovna oprema: odvodni ventil 3 1/2", preljevnik, rupa nije probijena, sa sifonom

| Br.art | Tip | Boja | Ocjeđivač | Vanjska mjera mm | JM | Cijena KM |
|-------------|---------|--------------|-------------|------------------|----|-----------|
| 113 548 453 | Riva 80 | bež | univerzalan | 960 x 500 | GT | 190,00 |
| 113 548 454 | Riva 80 | crna metalik | univerzalan | 960 x 500 | GT | 190,00 |

po **190,00** KM

GranMaster



UGRADBENI SUDOPER ASTER



Dimenzije korita: ø 400 x 190 mm
 Osnovna oprema: odvodni ventil 3 1/2", preljevnik, rupa nije probijena, sa sifonom

| Br.art | Tip | Materijal | Boja | Ocjeđivač | Vanjska mjera mm | JM | Cijena KM |
|-------------|-------|-----------|--------------|-------------|------------------|----|-----------|
| 113 548 463 | Aster | granit | bež | univerzalan | 780 x 470 | GT | 170,00 |
| 113 548 464 | Aster | granit | crna metalik | univerzalan | 780 x 470 | GT | 170,00 |

po **170,00** KM

GranMaster



UGRADBENI SUDOPER SONNO



Materijal: granit
 Dimenzije korita: ø 380 x 180 mm
 Osnovna oprema: odvodni ventil 3 1/2", preljevnik, rupa nije probijena, sa sifonom

| Br.art | Tip | Boja | Vanjska mjera mm | JM | Cijena KM |
|-------------|-------|--------------|------------------|----|-----------|
| 113 548 455 | Sonno | bež | ø 510 | GT | 130,00 |
| 113 548 456 | Sonno | crna metalik | ø 510 | GT | 130,00 |

po **130,00** KM

solido

UGRADBENI SUDOPER LARISSA EX-152



Materijal: nehrđajući čelik
 Dimenzije korita: 39 x 36 x 18 cm
 Osnovna oprema: odvodni ventil s mrežicom 3 1/2", s odvodnom cijevi, sifon Ø 40 mm

| | | | |
|---------------|----------------|-----------|-----------------|
| Br.art | Tip | JM | 90,00 KM |
| 113 523 014 | Larissa EX-152 | kom | |

solido

UGRADBENI SUDOPER VOLOS EX-325



Materijal: nehrđajući čelik
 Dimenzije korita: 36 x 18 cm
 Osnovna oprema: sifon s preljevnikom 3 1/2", s odvodnom cijevi, Ø 40 mm

| | | | |
|---------------|--------------|-----------|-----------------|
| Br.art | Tip | JM | 90,00 KM |
| 113 523 016 | Volos EX-325 | kom | |

solido

UGRADBENI SUDOPER KASSANDRA EX-149



Materijal: nehrđajući čelik
 Dimenzije korita: 39 x 36 x 18 cm
 Osnovna oprema: odvodni ventil s mrežicom 3 1/2", s odvodnom cijevi, sifon Ø 40 mm

| | | | |
|---------------|------------------|-----------|-----------------|
| Br.art | Tip | JM | 66,00 KM |
| 113 523 017 | Kassandra EX-149 | kom | |

solido

UGRADBENI SUDOPER PATRAS EX-146



Materijal: nehrđajući čelik
 Dimenzije korita: 39 x 19 cm
 Osnovna oprema: sifon s preljevnikom 3 1/2", odvodna cijev Ø 40 mm

| | | | |
|---------------|---------------|-----------|-----------------|
| Br.art | Tip | JM | 66,00 KM |
| 113 523 015 | Patras EX-146 | kom | |

solido



ECKSPÜLEN

UGRADBENI KUTNI SUDOPER BASE 50



Materijal: nehrđajući čelik
 Dimenzije korita: 350 x 400 x 180 mm
 Osnovna oprema: odvodni ventil s mrežicom 3 1/2", spoj za odvod, 1 rupa, sifon ø 40 mm

| | | | |
|---------------|-------------------------|-----------|-----------------|
| Br.art | Vanjska mjera mm | JM | 90,00 KM |
| 113 505 060 | 780 x 490 | kom | |

GM GranMaster

KUHINJSKE SLAVINE GM



Rupa za pipu ø: 35 mm

od **51,00** KM

| Br.art | Tip | Izvedba | JM | Cijena KM |
|---------------|------------|----------------------|-----------|------------------|
| 113 548 466 | Inoxa GM | krom | kom | 51,00 |
| 113 548 465 | Santa GM | crna/krom savitljiva | kom | 65,00 |



KOMBINIRANA STAKLOKERAMIČKA PLINSKA PLOČA EGE 6172NOK

2 plinska plamenika + 2 staklokeramička električna polja, automatsko paljenje plina, mehaničke kontrole, nosači od lijevanog željeza, jakost plamenika 1200-2700 W, zaštita od curenja plina, crno staklo.

Dimenzije: 580 x 510 mm

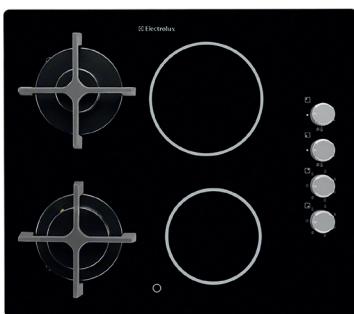

Širina: 60 cm
Izvedba: kombinacija plinske + elktro ploče

| | | | |
|---------------|--------------|-----------|------------------|
| Br.art | Tip | JM | |
| 112 592 333 | EGE 6172 NOK | kom | 429,00 KM |



STAKLOKERAMIČKA PLOČA EHF 6343 FOK

- dodirne kontrole
- automatsko isključivanje
- indikator preostale topline
- funkcija Stop&Go
- timer, zvučni signal
- brušeni rub
- dimenzije 590 x 520 mm
- snaga 6400 W



Širina: 60 cm
Polja za kuhanje: 4

| | | | |
|---------------|--------------|-----------|------------------|
| Br.art | Tip | JM | |
| 112 592 588 | EHF 6343 FOK | kom | 329,00 KM |



UGRADBENA PEĆNICA EZF5C50X

- SurroundCook - ravnomjerno grijanje pećnice vrućim zrakom
- LED-interaktivni zaslon
- sat s timerom
- zvučna signalizacija: trajanje, završetak, minutni podsjetnik, sat
- prikaz vremena: trenutačno, trajanje
- prikaz temperature: na regulatoru, indikator preostale topline



Klasa energetske učinkovitosti: A
Broj načina grijanja: 7
Izvedba: nehrđajući čelik

| | | | | |
|---------------|------------|------------------|-----------|------------------|
| Br.art | Tip | Sadržaj l | JM | |
| 112 592 711 | EZF5C50X | 57 | kom | 405,00 KM |



UGRADBENA PERILICA POSUĐA EEM48320L

- BeamOnFloor® projekcija na pod crvene i/ili zelene točke
- AirDry prirodno sušenje - auto otvaranje vrata
- QuickSelect - slider za optimalan odabir ciklusa
- 2 prskalice, 3 razine prskanja, SatelliteClean donja prskalica



Izvedba: potpuno integrirana
Širina x visina: 596 x 818
Klasa energetske učinkovitosti: A+++
Potrošnja struje u 365 dana: 237 kW-h
Potrošnja: 10,5 l
Broj programa: 8
Programi: 160 minuta, 60 minuta, 90 minuta, AUTO Sense, Eko, Machine Care, Quick 30 minuta, ispiranje i zaustavljanje
Razina buke: 44 dB
Košara za pribor za jelo: ladica

| | | | |
|---------------|------------|-----------|------------------|
| Br.art | Tip | JM | |
| 112 592 716 | EEM48320L | kom | 718,00 KM |



UGRADBENI KOMBINIRANI HLADNJAK ENN 2300 AOW

- Mehanička kontrola temperature
- Automatsko odmrzavanje rashladnog pretinca
- Broj i vrsta ladica zamrzivača: 2 duboke, prozirne plastične
- Polica na vratima s pola širine - pomična radi veće fleksibilnosti

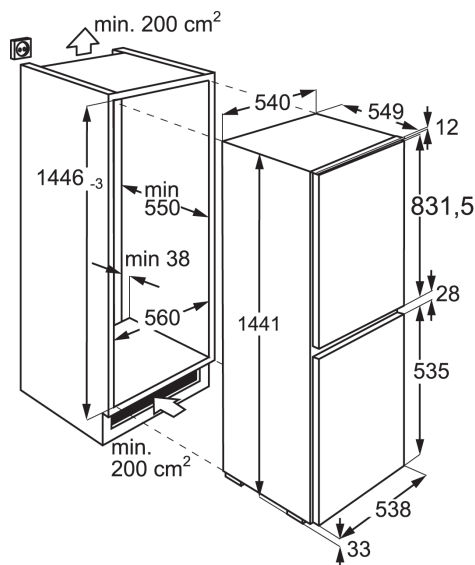

Klasa energetske učinkovitosti: A+
 Potrošnja struje u 365 dana: 259 kW·h
 Volumen: 217 l
 Razina buke: 35 dB

| Br.art | Visina niše cm | JM |
|-------------|----------------|-----|
| 112 592 665 | 144.6 | kom |

605,⁰⁰ KM



ZIDNA NAPA MISSY

- priključak odvoda 150 mm



od **109,⁰⁰** KM

Izvedba: odvod
 Kapacitet: 392 m³/h
 Klasa energetske učinkovitosti: D
 Potrošnja struje u 365 dana: 57 kW·h
 Izvedba: nehrđajući čelik
 Rasvjeta: 2 x 3 W LED 3700 K
 Razina buke: 49 - 68 dB

| Br.art | Tip | JM | Cijena KM |
|-------------|-----------------|-----|-----------|
| 112 592 733 | Missy LV IX A60 | kom | 109,00 |
| 112 592 734 | Missy LV IX A90 | kom | 135,00 |



ZIDNA NAPA WISE

- priključak odvoda 150 mm



od **340,⁰⁰** KM

Izvedba: odvod
 Kapacitet: 691 m³/h
 Klasa energetske učinkovitosti: B
 Potrošnja struje u 365 dana: 76 kW·h
 Izvedba: crno staklo
 Rasvjeta: 2 x 1,3 W LED 4000 K
 Razina buke: 48 - 65 dB

| Br.art | Tip | JM | Cijena KM |
|-------------|-------------|-----|-----------|
| 112 592 731 | Wise BL A60 | kom | 340,00 |
| 112 592 732 | Wise BL A90 | kom | 365,00 |

VS TAL GATE IZVLAČNA KOLONA S KOŠARAMA PLANERO

- maksimalno skladištenje i optimalan pristup
- EasyFit: montaža okvira bez uporabe alata na donjoj vodilici
- EasyFit: veza između prihvatnika i nosivog okvira bez uporabe alata
- individualno podešavanje košara po visini
- veličina košare: ŠxDxV = 350x395x125 mm ili 500x395x125 mm
- okvir je po visini moguće izvući do 250 mm

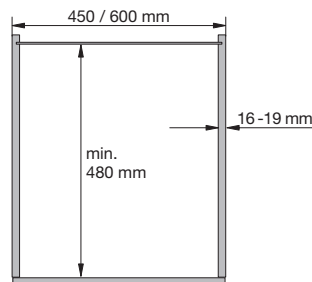
**Napomena:**

Kako bi se spriječio naginjanje ormara, ormar se mora pričvrstiti za zid. Odgovarajući pričvrstni pribor ne isporučuje se uz okov.

Opseg isporuke:

nosivi okvir
Planero košare
prihvatnik
vodilica

Ugradna dubina min.: 480 mm
Nosivost: 15 kg/košara
Materijal: dno drvo / bočni zid čelik
Dekor: lavasivo

| Br.art | Širina korpusa mm | Ugradna visina mm | Broj košara | JM | Cijena KM |
|-------------|-------------------|-------------------|-------------|----|-----------|
| 103 378 390 | 450 | 1200-1450 | 4 | GT | 730,00 |
| 103 378 391 | 450 | 1450-1700 | 4 | GT | 735,00 |
| 103 378 392 | 450 | 1700-1950 | 5 | GT | 835,00 |
| 103 378 393 | 450 | 1900-2140 | 5 | GT | 840,00 |
| 103 378 394 | 600 | 1200-1450 | 4 | GT | 760,00 |
| 103 378 395 | 600 | 1450-1700 | 4 | GT | 765,00 |
| 103 378 397 | 600 | 1700-1950 | 5 | GT | 870,00 |
| 103 378 398 | 600 | 1900-2140 | 5 | GT | 875,00 |

od **730,00** KM

VS COR FLEX KUTNI IZVLAČNI OKOV

- potpun pristup potpunom prostoru u kutnom elementu
- montaža neovisna o strani
- individualno podesiva visina polica za odlaganje
- integriran ublaživač i samouvlačenje u oba izvlačenja
- šablona za ugradnju: nema mjerenja kod ugradnje u korpus

Opseg isporuke: kutni okov, 4 košare

Izvedba: polica Planero
Ugradna visina min.: 530 mm
Ugradna dubina min.: 480 mm
Nosivost: 8 kg/košara
Materijal: čelik/dno drvo
Dekor: lavasivo

| Br.art | Širina korpusa mm | Širina krila mm | JM | Cijena KM |
|-------------|-------------------|-----------------|----|-----------|
| 103 378 387 | 900 | 450 | GT | 730,00 |
| 103 378 388 | 1000 | 500 | GT | 755,00 |



od **730,00** KM



VS ENVI FREE SPREMNIK

- individualno umetanje u izvlačnu ladicu
- naknadno postavljanje u svim izvlačnim sustavima
- postavljanje neovisno od širine
- može doći u dodir s hranom, perivo u perilici za suđe



od **25,00** KM

Tip: VS ENVI Free/VS ENVI Space
Materijal: plastika
Dekor: lava siva

| Br.art | Sadržaj l | Š x V x D mm | JM | Cijena KM |
|---------------|-----------|-----------------|-----|-----------|
| 103 370 050 • | 10 | 230 x 216 x 302 | kom | 31,00 |
| 103 370 051 • | 10 | 183 x 216 x 382 | kom | 30,00 |
| 103 370 056 • | 10 | 230 x 326 x 191 | kom | 27,00 |
| 103 370 057 • | 12 | 183 x 326 x 302 | kom | 35,00 |
| 103 370 062 • | 12.5 | 230 x 426 x 191 | kom | 39,00 |
| 103 370 052 • | 13 | 230 x 216 x 382 | kom | 33,00 |
| 103 370 058 • | 15.5 | 230 x 326 x 302 | kom | 39,00 |
| 103 370 059 • | 16 | 183 x 326 x 382 | kom | 36,00 |
| 103 370 053 • | 18 | 315 x 216 x 382 | kom | 40,00 |
| 103 370 063 • | 21 | 183 x 426 x 382 | kom | 41,00 |
| 103 370 060 • | 22 | 230 x 326 x 382 | kom | 41,00 |
| 103 370 064 • | 28 | 230 x 426 x 382 | kom | 43,00 |
| 103 370 061 • | 29 | 315 x 326 x 382 | kom | 46,00 |
| 103 370 065 • | 39 | 315 x 426 x 382 | kom | 49,00 |
| 103 370 047 • | 5.5 | 113 x 216 x 382 | kom | 30,00 |
| 103 370 048 • | 6 | 230 x 216 x 191 | kom | 25,00 |
| 103 370 049 • | 7.5 | 183 x 216 x 302 | kom | 29,00 |
| 103 370 054 • | 8.5 | 113 x 326 x 382 | kom | 33,00 |



VS ENVI SPACE BIO POKLOPAC

- BIO poklopac s ugljenim filterom za sustav za razvrstavanje otpada VS ENVI Space (opcija)
- filtrira i neutralizira neugodne mirise kuhinjskog otpada

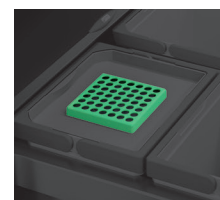

od **13,00** KM

Materijal: plastika
Dekor: lavasiva

| Br.art | Ugradnja za spremnik | Dimenzija mm | JM | Cijena KM |
|---------------|----------------------|--------------|-----|-----------|
| 103 370 067 • | 7,5/12 litara | 162 x 282 | kom | 18,00 |
| 103 370 069 • | 6/10/12,5 litara | 210 x 169 | kom | 13,00 |
| 103 370 070 • | 10/15,5 litara | 210 x 282 | kom | 18,00 |



SERVO-DRIVE UNO SET ZA IZVLAČNU KANTU ZA SMEĆE EINS2VIER

- visoki komfor
- brza montaža zahvaljujući predmontaži – bez mjerenja i bušenja
- zaštita od naslanjanja sprječava slučajno otvaranje
- osjetljivo prepoznavanje kolizije
- integrirana zaštita od kapanja
- niska potrošnja struje
- idealno za naknadno opremanje (u kombinaciji s Blum izvlačnim sustavima)



Opseg isporuke:

predmontirana jedinica
SERVO-DRIVE
prihvatni kutnik
pogonska jedinica
transportna zaštita
zaštita od kapanja
utični mrežni dio s mrežnim adapterom i kabelom 1m
pomagalo pri montaži
odbojnik
vijci
upute za montažu
upute za rukovanje

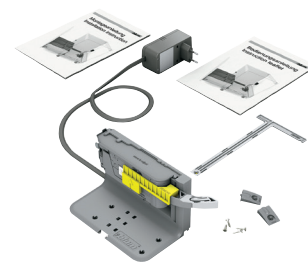

Ugradnja: za izvlačnu kantu za smeće eins2vier

| Br.art | Tvornički broj | JM | Cijena KM |
|---------------|----------------|----|---------------|
| 103 358 041 • | Z10NA20EA01 | GT | 235,00 |



PODGRADNA SVJETILJKA POLAR 24 V/DC

Tanka podgradna LED svjetiljka s jakim osvjetljenjem.

Napomena:

odgovara svim LED mrežnim uređajima s istom oznakom (pogledajte piktogram).

Duljina: 190 mm
 Širina: 70 mm
 Visina: 4 mm
 Ugradnja: ugradnja vijcima
 Svjetlosni tok (Lumen): 375
 Materijal: aluminij
 Dekor: eloksirano

| Br.art | Boja svjetla | Snaga W | JM | Cijena KM |
|-------------|------------------------|---------|-----|-----------|
| 103 333 433 | 3000 K toplo bijela | 5 | kom | 25,00 |
| 103 333 434 | 4000 K prirodno bijela | 5 | kom | 25,00 |

A+



LED

24 VDC

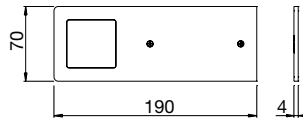

po **25,00** KM



UGRADBENA RASVJETA LD 8001B 230 V

LED svjetiljka sa svjetlom bez vidljivih LED točki
 Bijela površina u isključenom modusu

Napomena:

nije potreban transformator. Odgovara uz Mini-sustav utikača
 Za ovu rasvjetu nije moguće koristiti potenciometar.

Tip: LD 8001B-58
 Izvedba: moguće prigušivanje
 ø: 62 mm
 Visina: 2,7 mm
 Ugradnja ø: 58 mm
 Ugradna dubina: 13,5 mm
 Ugradnja: pričvršćivanje stezanjem
 Materijal: plastika
 Dekor: crne boje

| Br.art | Boja svjetla | Svjetlosni tok (Lumen) | Snaga W | JM | Cijena KM |
|-------------|-------------------------|------------------------|---------|-----|-----------|
| 103 377 964 | 3000 K toplo bijela | 110 | 2,6 | kom | 55,00 |
| 103 377 965 | 4000 K neutralna bijela | 140 | 2,6 | kom | 55,00 |

A++



LED

230 V

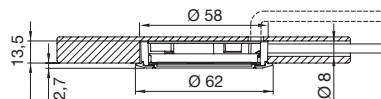

po **55,00** KM



STEZNA RASVJETA ZA OGLEDALA PULSE 12 V/DC

Kvadratna, moderna rasvjeta za ogledala, montaža stezanjem direktno na ogledalo.

- površinsko osvjetljenje bez tipičnih LED točki
- optimalna raspodjela svjetlosti

Izvedba 3: priključni kabel s utikačem
 Širina: 75 mm
 Visina: 75 mm
 Dubina: 26 mm
 Duljina priključnog kabela: 1200 mm
 Ugradnja: pričvršćivanje stezanjem (maks. 6 mm debljina stakla)
 Svjetlosni tok (Lumen): 250
 Materijal: metal, plastika

| Br.art | Boja svjetla | Snaga W | Dekor | JM | Cijena KM |
|-------------|------------------------|---------|--------------|-----|-----------|
| 103 373 618 | 2800 K topla bijela | 4,8 | krom, bijelo | kom | 49,00 |
| 103 373 619 | 3800 K prirodno bijela | 4,8 | krom, bijela | kom | 49,00 |

A A+ A++



IP 44



LED

12 VDC

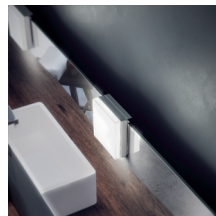
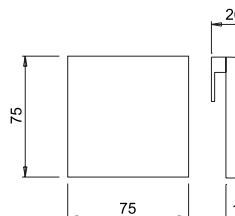

po **49,00** KM



DOMUS Line®

A+



IP 44



0,8m

230 V

LED

NADGRADNA RASVJETA ZA OGLEDALO AALTO 230 V

Moderna rasvjeta za ogledalo ravnih linija s integriranim mrežnim uređajem, direktno za 230 V.

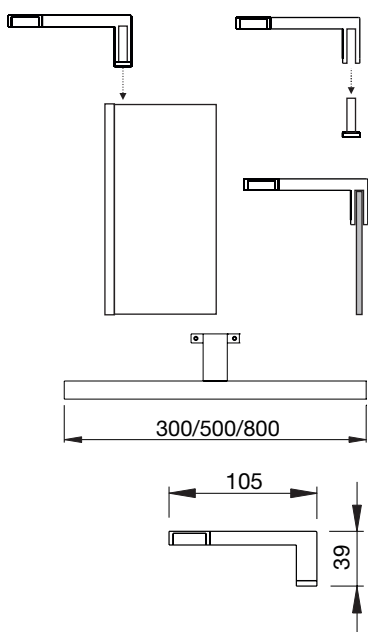

Izvedba 3: integriran mrežni uređaj
 Visina: 39 mm
 Dubina: 105 mm
 Materijal: metal

| Br.art | Širina mm | Boja svjetla | Svjetlosni tok (Lumen) | Snaga W | Dekor | JM | Cijena KM |
|-------------|-----------|------------------------|------------------------|---------|-----------|-----|-----------|
| 103 377 855 | 300 | 3000 K topla bijela | 400 | 5 | crno mat | kom | 70,00 |
| 103 377 856 | 500 | 3000 K topla bijela | 640 | 8 | crno mat | kom | 106,00 |
| 103 373 964 | 300 | 4000 K prirodno bijela | 400 | 5 | crno mat | kom | 60,00 |
| 103 373 965 | 500 | 4000 K prirodno bijela | 640 | 8 | crno mat | kom | 87,00 |
| 103 377 852 | 800 | 3000 K topla bijela | 1040 | 13 | kromirano | kom | 135,00 |
| 103 377 851 | 500 | 3000 K topla bijela | 640 | 8 | kromirano | kom | 85,00 |
| 103 333 431 | 300 | 3000 K topla bijela | 400 | 5 | kromirano | kom | 60,00 |
| 103 377 854 | 800 | 4000 K prirodno bijela | 1040 | 13 | kromirano | kom | 135,00 |
| 103 333 432 | 300 | 4000 K prirodno bijela | 400 | 5 | kromirano | kom | 67,00 |
| 103 377 853 | 500 | 4000 K prirodno bijela | 640 | 8 | kromirano | kom | 85,00 |

od **60,00** KM



DOMUS Line®



12 VDC

24 VDC

LED SENZORSKI PREKIDAČ DOTTI 12/24 V/DC

DOTTI je ukrasni aluminijski prekidač. Funkcionira dodiranjem kućišta senzora. Senzorski prekidač se spaja između mrežnog uređaja i svjetiljke.

Funkcije: kratki kontakt = On/Off, duži kontakt = prigušivanje.

Opseg isporuke: Uklj. priključni kabel i razdjelnik odgovarajući za 12 V/DC i 24 V/DC-sustav (pogledajte piktogram).

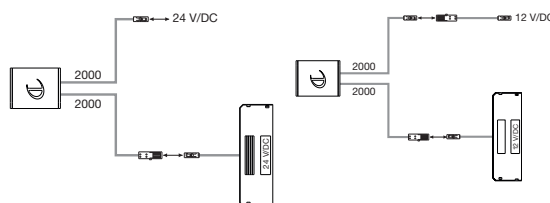

Ugradnja: montaža vijcima
 Napon: 12/24 V/DC
 Primar: kabel 2000 mm sa LED utikačem
 Sekundar: kabel 2000 mm sa 10-strukim razdjelnikom

| Br.art | maks. snaga W | Duljina mm | Širina mm | Visina mm | Materijal | Dekor | JM |
|-------------|---------------|------------|-----------|-----------|-----------|------------|-----|
| 103 377 491 | 36 | 38 | 32 | 10 | aluminij | eloksirano | kom |

26,00 KM



LED MREŽNI UREĐAJ SL 6/12R 12 V/DC

Napomena: odgovara svim LED-svjetiljkama s istom oznakom (pogledajte piktogram).

Primar: kabel 2000 mm s Euro utikačem
 Sekundar: kabel 500 mm s 10-strukim razdjelnikom
 Napon: 12 V/DC
 Materijal: plastika siva

| Br.art | Snaga W | Duljina mm | Širina mm | Visina mm | JM |
|-------------|---------|------------|-----------|-----------|-----|
| 103 371 192 | 6 | 58 | 35 | 20 | kom |

LED System 03 12 V/DC



LED

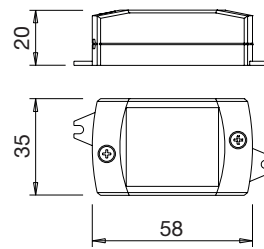

18,00 KM



LED MREŽNI UREĐAJ SL 15/12R 12 V/DC

Napomena: odgovara svim LED-svjetiljkama s istom oznakom (pogledajte piktogram).

Primar: kabel 2000 mm s Euro utikačem
 Sekundar: kabel 500 mm s 10-strukim razdjelnikom
 Napon: 12 V/DC
 Materijal: plastika siva

| Br.art | Snaga W | Duljina mm | Širina mm | Visina mm | JM |
|-------------|---------|------------|-----------|-----------|-----|
| 103 371 193 | 15 | 120,5 | 45 | 16 | kom |

LED System 03 12 V/DC



LED

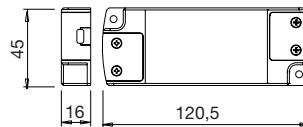

19,00 KM



LED MREŽNI UREĐAJ NG39 12 V/DC

Napomena: odgovara svim LED-svjetiljkama s istom oznakom (pogledajte piktogram).

Primar: kabel 2000 mm s Euro plosnatim utikačem
 Sekundar: kabel 500 mm sa 10-strukim razdjelnikom (92x30x11 mm)
 Materijal: plastika siva

| Br.art | Duljina mm | Širina mm | Visina mm | Snaga W | JM |
|-------------|------------|-----------|-----------|---------|-----|
| 103 372 703 | 255 | 30 | 16 | 30 | kom |



12 VDC

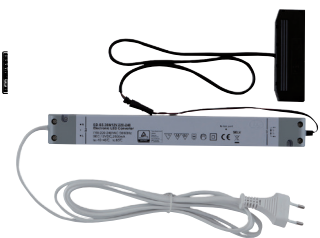
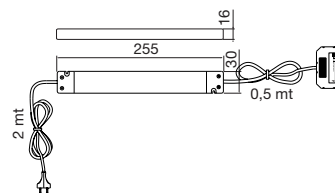

35,00 KM



LED MREŽNI UREĐAJ FLAT 15/24D 24 V/DC

Napomena: odgovara svim LED svjetiljkama s istom oznakom (pogledajte piktogram).

Primar: kabel 2000 mm s Euro plosnatim utikačem
 Sekundar: kabel 500 mm sa 6-strukim razdjelnikom
 Napon: 24 V/DC
 Materijal: plastika
 Dekor: bijelo

| Br.art | Snaga W | Duljina mm | Širina mm | Visina mm | JM |
|-------------|---------|------------|-----------|-----------|-----|
| 103 333 435 | 15 | 120,5 | 45 | 16 | kom |



24 VDC

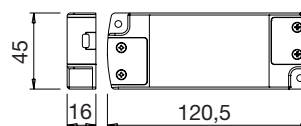

21,00 KM

RUČKICA ZA NAMJEŠTAJ ARONA



Materijal: aluminij
 Dekor: nehr. čel. završna obrada
 Razmak rupa mm: 160
 Dubina mm: 25

| Br.art | Širina mm | Visina mm | JM |
|-------------|-----------|-----------|-----|
| 103 305 023 | 228 | 20 | kom |

5,50 KM

RUČKICA ZA NAMJEŠTAJ TIRAJA



Materijal: lijevani cink
 Dekor: nehr. čel. završna obrada
 Razmak rupa: 192
 Dubina mm: 30

| Br.art | Širina mm | Visina mm | JM |
|-------------|-----------|-----------|-----|
| 103 305 028 | 204 | 9 | kom |

5,80 KM

PROFILNA RUČKICA ARRECIFE



Materijal: aluminij
 Dekor: nehr. čel. mat završna obrada
 Ugradnja: za upuštanje

od **7,00** KM

| Br.art | Duljina mm | Visina mm | Dubina mm | JM | Cijena KM |
|-------------|------------|-----------|-----------|-----|-----------|
| 103 305 069 | 296 | 38 | 14 | kom | 7,00 |
| 103 305 075 | 396 | 38 | 14 | kom | 9,00 |
| 103 305 076 | 446 | 38 | 14 | kom | 10,00 |
| 103 305 077 | 496 | 38 | 14 | kom | 11,00 |
| 103 305 101 | 596 | 38 | 14 | kom | 13,00 |
| 103 305 118 | 796 | 38 | 14 | kom | 16,50 |
| 103 305 119 | 896 | 38 | 14 | kom | 18,50 |



NOGICA SOKLA GEO

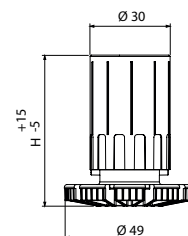

Cijev ø: 30 mm
 Raspon podešavanja: +15/-5 mm
 Nosivost: 400 kg
 Materijal: plastika crna

od **78,00** KM/100

| Br.art | Visina sokla mm | JM | Cijena KM/100 |
|---------------|-----------------|-----|---------------|
| 103 324 290 • | 60 | kom | 78,00 |
| 103 324 291 • | 80 | kom | 95,00 |
| 103 324 292 • | 100 | kom | 98,00 |



GORNJI DIO ZA NOGICU SOKLA 0400



Materijal: plastika crna

| Br.art | Izvedba | JM |
|---------------|------------------|-----|
| 103 324 293 • | za cijev ø 30 mm | kom |

33,00 KM/100



GORNJI KLIZAČ GEO II



Dimenzija: 60 x 80 mm
 Ugradnja: vijci
 Materijal: plastika crna

| Br.art | Materijal | JM |
|---------------|---------------|-----|
| 103 324 294 • | plastika crna | kom |

35,00 KM/100



ALAT ZA PODEŠAVANJE NOGICA SOKLA GEO

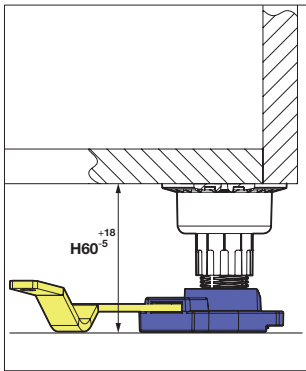
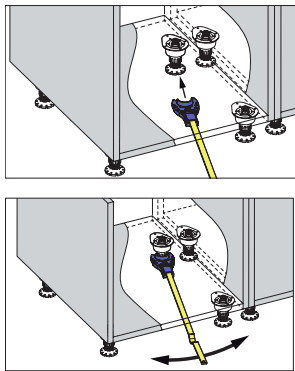

Br.art **Materijal** **JM**
103 324 295 • metal/plastika-plavo/žuto kom

14,00 KM



PLASTIČNI SOKL

- presvučeni folijom
- moguće skraćivati po dužini
- s potrebnim priborom (naručuje se posebno), moguće spajanje pod svim kutevima
- pričvršćenje na nogice s odgovarajućom klipsom (naručuje se posebno)

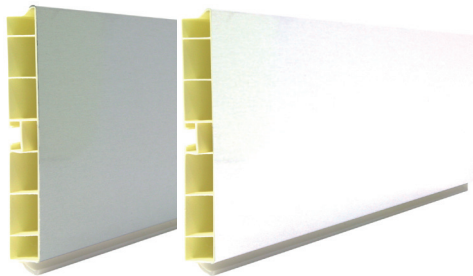
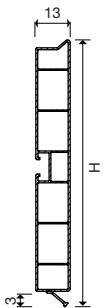

od **16,50** KM

Duljina: 4000 mm
 Dubina: 13 mm
 Materijal: plastika

| Br.art | Visina mm | Dekor | JM | Cijena KM |
|-------------|-----------|-------------------------|-----|-----------|
| 103 334 281 | 100 | alu efekt nehrđ. čelika | kom | 20,00 |
| 103 334 282 | 150 | alu efekt nehrđ. čelika | kom | 27,00 |
| 103 324 700 | 100 | alu natur | kom | 16,50 |
| 103 324 706 | 150 | alu natur | kom | 25,50 |
| 103 338 474 | 100 | bijelo visoki sjaj | kom | 16,50 |
| 103 338 475 | 150 | bijelo visoki sjaj | kom | 21,50 |
| 103 338 094 | 100 | crna, visoki sjaj | kom | 16,50 |
| 103 338 095 | 150 | crna, visoki sjaj | kom | 21,50 |



FLEKSIBILNI KUTNIK ZA ALUMINIJSKI SOKL

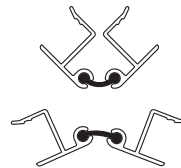

od **1,25** KM

Materijal: aluminij
 Dekor: prirodno eloksirano

| Br.art | Visina mm | JM | Cijena KM |
|-------------|-----------|-----|-----------|
| 103 334 294 | 100 | kom | 1,25 |
| 103 334 295 | 100 | kom | 1,80 |



FLEKSIBILNI KUTNIK ZA PLASTIČNI SOKL

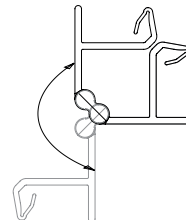

od **1,10** KM

Materijal: plastika

| Br.art | Dekor | Visina mm | JM | Cijena KM |
|-------------|--------------------|-----------|-----|-----------|
| 103 338 476 | bijelo visoki sjaj | 100 | kom | 1,10 |
| 103 338 477 | bijelo visoki sjaj | 150 | kom | 1,35 |
| 103 338 096 | crna, visoki sjaj | 100 | kom | 1,10 |
| 103 338 097 | crna, visoki sjaj | 150 | kom | 1,35 |



RUBNA LETVA ZA RADNU PLOČU 12/25

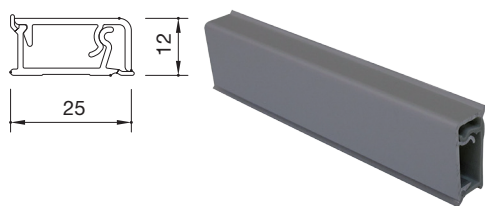

Materijal: plastika/aluminij
D x Š x V mm: 4200 x 25 x 12

| Br.art | Dekor | JM | Cijena KM |
|-------------|---------------------|-----|-----------|
| 103 334 306 | prirodno eloksirano | kom | 20,00 |
| 103 334 325 | efekt nehrd. čelika | kom | 27,00 |

od **20,00** KM



PRIBOR 12/25

- odgovara za rubnu letvu 12/25

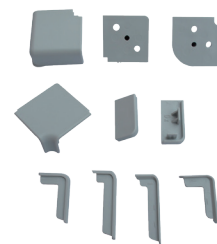

Boja: siva

| Br.art | Materijal | JM | Cijena KM |
|-------------|--------------|----|----------------|
| 103 334 310 | plastika Set | | 0,85 KM |



RUBNA LETVA ZA RADNU PLOČU RIFFLE

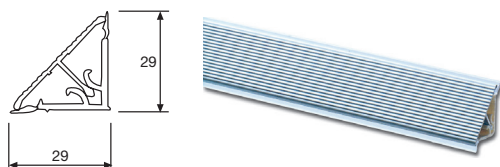

Materijal: aluminij

| Br.art | Duljina mm | Dekor | JM | Cijena KM |
|-------------|------------|----------|-----|-----------------|
| 103 334 307 | 4000 | rebrasto | kom | 21,00 KM |



KUTNICI ZA RUBNU LETVU RIFFLE

Opseg isporuke:

- po 1 završna kapica lijevo i desno, 1 vanjski kut, 1 unutarnji kut, 1 unutarnji kut od 135°

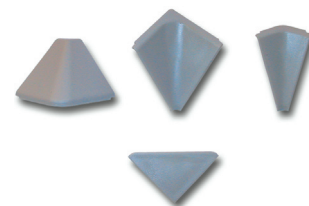

Odgovara za: završni profil Riffle

| Br.art | Materijal | JM | Cijena KM |
|-------------|--------------|----|----------------|
| 103 334 311 | plastika Set | | 0,85 KM |



RUBNA LETVA ZA RADNU PLOČU 29/29 - 4200

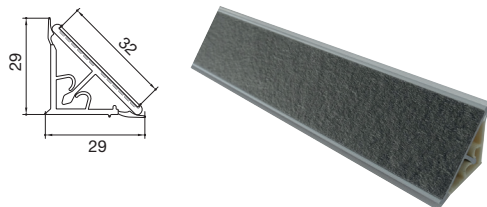

Dekor: boja aluminija
D x Š x V: 4200 x 29 x 29 mm

| Br.art | Materijal | JM | Cijena KM |
|-------------|------------------|-----|-----------------|
| 103 334 303 | plastika/laminat | kom | 18,00 KM |



RUBNA LETVA ZA RADNU PLOČU 29/29 - 4000

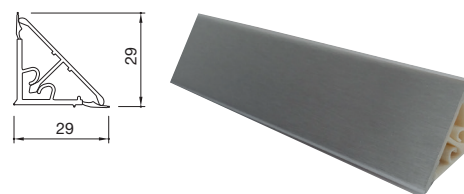

Dekor: boja aluminija, fino rebrasto
D x Š x V: 4000 x 29 x 29 mm

| Br.art | Materijal | JM | Cijena KM |
|-------------|-----------|-----|-----------------|
| 103 335 024 | plastika | kom | 16,00 KM |

GARNITURA OKOVA ZA KLIZNA VRATA 40 KG

- bez vodilice

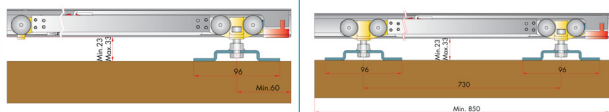

Jednostrano

Dvostrano

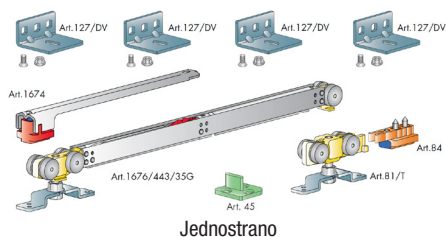

Jednostrano

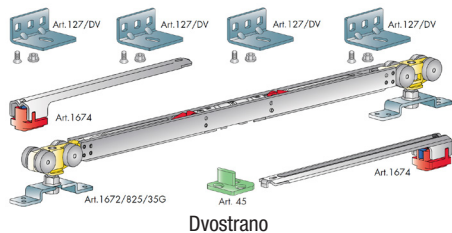

Dvostrano

od **80,00** KM

Širina krila do: 1350 mm
Nosivost: 40 kg

| Br.art | Izvedba | Širina krila od mm | JM | Cijena KM |
|-------------|---------------------------|--------------------|----|-----------|
| 102 221 035 | • jednostrani zaustavljač | 600 | GT | 80,00 |
| 102 221 036 | • dvostrani zaustavljač | 850 | GT | 120,00 |

GARNITURA OKOVA ZA STAKLENA KLIZNA VRATA

- bez vodilice

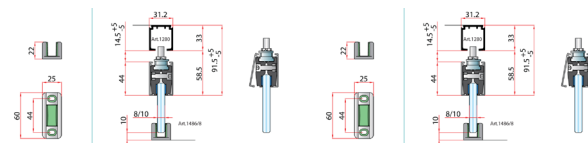

Jednostrano

Dvostrano

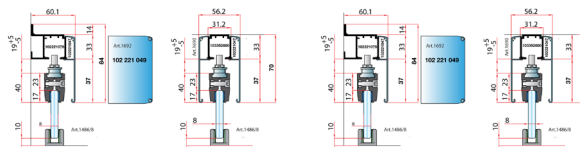

Jednostrano

Dvostrano

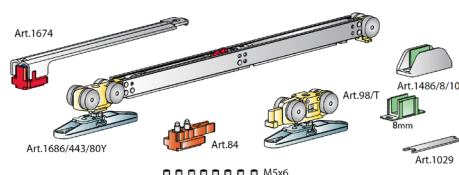

Jednostrano

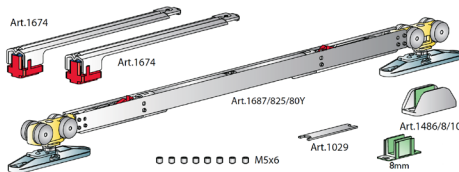

Dvostrano

od **110,00** KM

Nosivost: 80 kg

| Br.art | Izvedba | Širina krila od mm | JM | Cijena KM |
|-------------|---------------------------|--------------------|----|-----------|
| 102 221 039 | • jednostrani zaustavljač | 700 | GT | 112,00 |
| 102 221 040 | • dvostrani zaustavljač | 850 | GT | 110,00 |

VODILICA GORNJA

Gornja vodilica sa zaštitnom folijom, perforirana za 40, 60 i 100 kg.

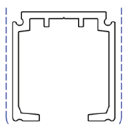

Dimenzija: 31,2 x 33,2 mm
Usluga: rezanje na mjeru moguće uz doplatu!
Materijal: aluminij srebrno eloksirani

| Br.art | Duljina mm | JM | Cijena KM |
|-------------|------------|----|-------------------|
| 102 222 457 | 6000 mm | | 10,00 KM/m |

GORNJI DRŽAČ STAKLA



od **70,00** KM

Materijal: aluminij

| Br.art | Duljina mm | Deblj. stakla mm | JM | Cijena KM |
|-------------|---------------|------------------|-----|-----------|
| 102 221 041 | • 700 - 799 | 8 | Set | 70,00 |
| 102 221 042 | • 800 - 899 | 8 | Set | 79,00 |
| 102 221 043 | • 900 - 999 | 8 | Set | 88,00 |
| 102 221 044 | • 1000 - 1099 | 8 | Set | 95,00 |
| 102 221 045 | • 1200 - 1299 | 8 | Set | 80,00 |

Schachermayer d.o.o.

BA-Sarajevo 71000, Džemala Bijedića 156
Tel.: 033 775 344, 345
Fax: 033 775 330

Odjel unutarnje uređenje
033 775 338; 033 775 339

Odjel građevina - metal - staklo
033 775 334; 033 775 335

Odjel specijalizirane trgovine
033 775 341

BA-Mostar 88000, Bišće polje bb
Tel.: 036 350 302
Fax: 036 352 781

BA-Banja Luka 78000, Branka Popovića 126
Tel.: 051 378 400
Fax: 051 378 402

SCH Internacionalno

Mađarska - Češka - Slovenija - Slovačka -
Austrija - Poljska - Hrvatska- Rumunjska -
Srbija - Italija - Njemačka

unutarnje uređenje
akcija 05/2019

